

소요 수 QTY		품 번 ITEM	품 명 DESCRIPTION	재 질 MATERIAL	규 격 SPECIFICATION	비 고 REMARK
	G02	G01	01	Out Line	APMC-FALR5AM8K2	Key, Brake Type
	1		02	Out Line	APMC-FAL01AM8K2	Key, Brake Type

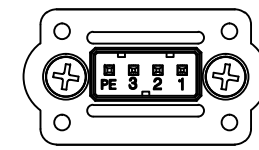
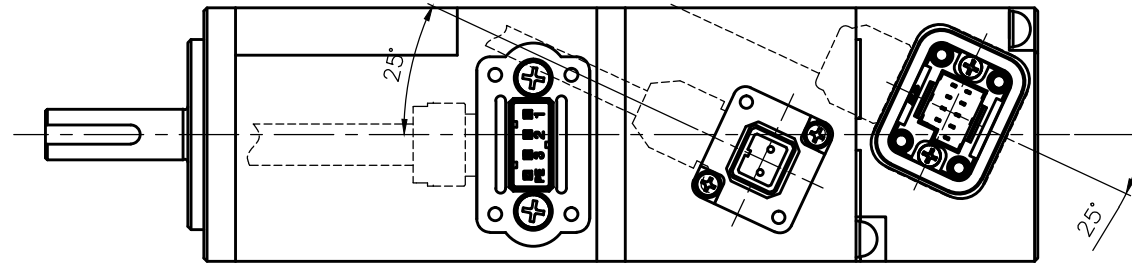

Pin No.	Phase
1	U
2	V
3	W
PE	FG

SC-MC4P-A2

<Power Connector 핀 배열>

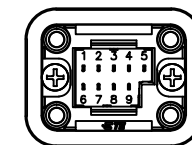

Pin No.	Encoder Phase	Pin No.	Encoder Phase
1	MA	6	MA
2	SLO	7	SLO
3	GND_B	8	VDD_B
4	OV	9	+5V
5	Shield		

BASE ASSY : 2108418-1
HSG : 2108422-1
CONTACT : 2069391-2

<Encoder Connector 핀 배열>

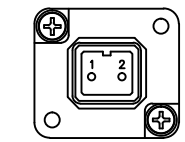

Pin No.	Phase
1	B1
2	B2

JN4AT02PJ1-R
or SC-MC2P-A1

<Brake Connector 핀 배열>

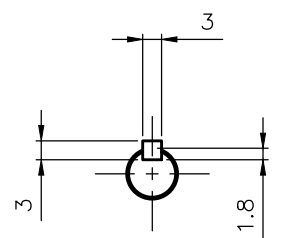
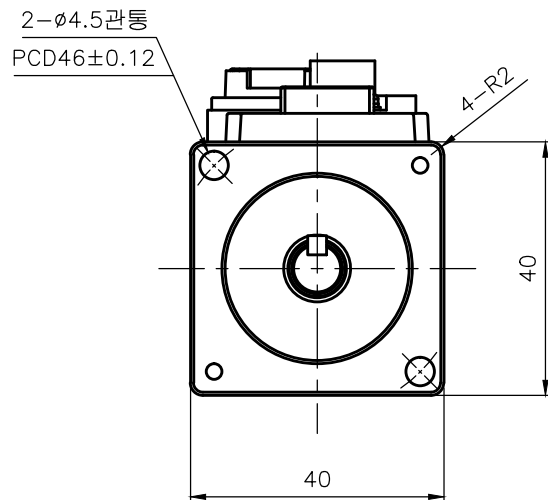

<Shaft Dimensions>

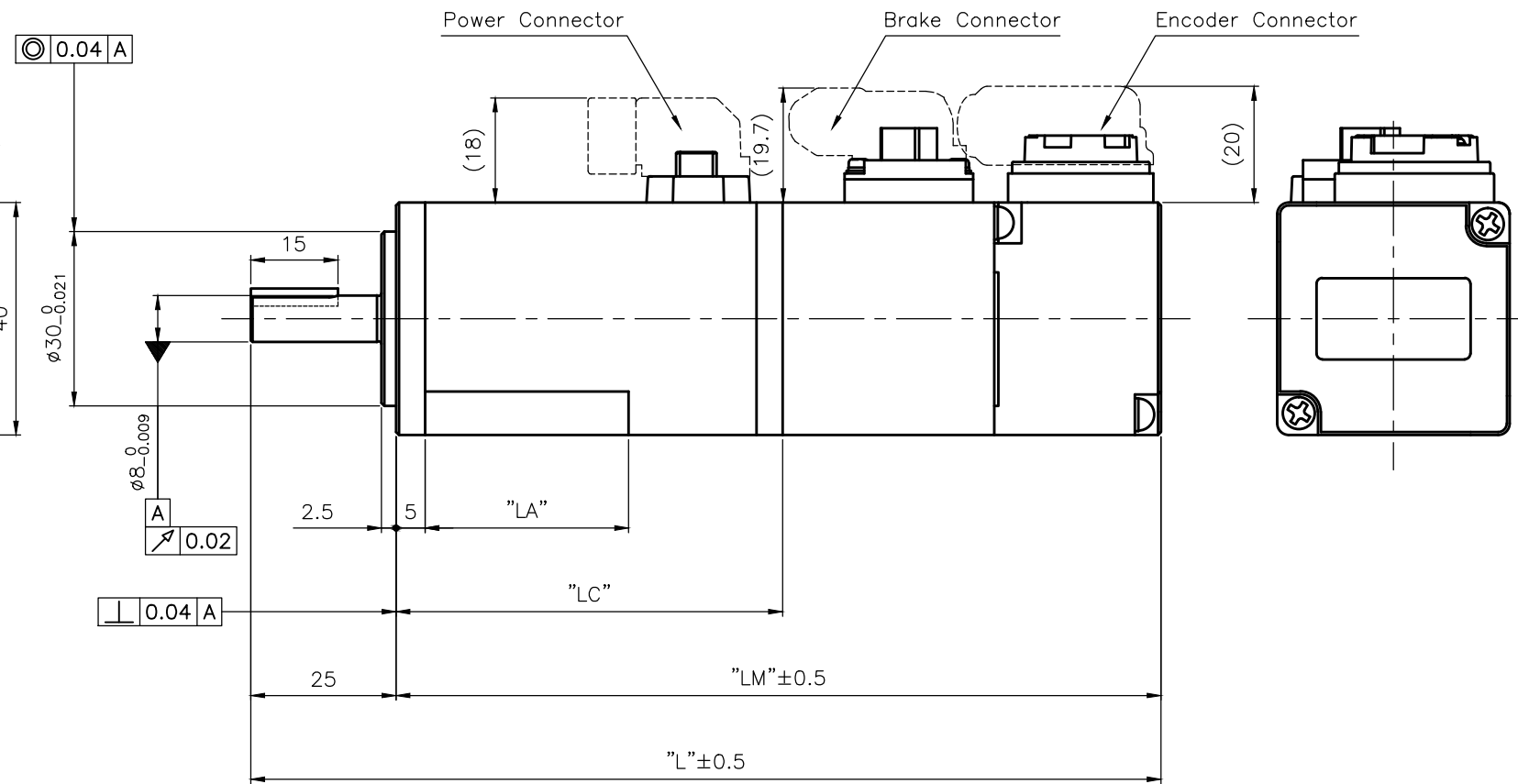

<외형 치수>

군 번	Part No.	모델명	L	LM	LC	LA
G01	47160813	APMC-FALR5AM8K2	139.6	114.6	49.5	23
G02	47160814	APMC-FAL01AM8K2	156.6	131.6	66.5	35

무지정 공차	
치수 구분	기본 공차
~3mm 이하	±0.10
3~6mm 이하	±0.12
6~10mm 이하	±0.15
10~18mm 이하	±0.18
18~30mm 이하	±0.21
30~50mm 이하	±0.25
50~80mm 이하	±0.30
80~120mm 이하	±0.35
120~180mm 이하	±0.40
180~250mm 이하	±0.46
250~315mm 이하	±0.52
315~400mm 이하	±0.57
400~500mm 이하	±0.63
500mm 초과	±0.70

개

CHANGE

개



	삼 각 법 3RD ANGLE PROJECTION	척 도 SCALE 1/1 (N.S)	제 품 명 PRODUCT NAME FAL Servo Motor
	단 위 UNIT MM	일 자 DATE 2018.11.01	도 면 명 칭 TITLE Out Line (Key, Brake Type)
설 계 DESIGNED	검 도 CHECKED	승 인 APPROVED	도 면 번 호 DWG. NO. SLM04GA004
			참조 도 면 REF. NO.
			Ver 1.0